

# APEX



**Coachmen**<sup>®</sup>  
Recreational Vehicles

**LIGHTWEIGHT • EASY TO TOW**

**YOUR FULL LINE FOR  
ULTRA LITE ADVENTURE**

**APEX – BUILT RUGGED  
BUT LIGHT AS A FEATHER**

**COACHMEN, A TRUSTED NAME  
FOR OVER 55 YEARS (EST. 1964)**





**HIT THE ROAD TO ADVENTURE WITH  
APEX'S ULTRA LITE TOWABLE RVS**

The Apex full line of Ultra Lites are ideal for towing with half ton trucks and most smaller SUV's, with weights ranging from under 3000 lbs. up to 6500 lbs. All Apex floor plans are designed with rich, warm interiors, full-sized bathrooms, contemporary cabinetry, fabrics and flooring. These lightweight, durable, travel trailers are constructed with double laminated Azdel composite sidewalls, a vacuum-bonded, aluminum framed roof, and a laminated, insulated floor.



**208BHS NANO TRAVEL TRAILER**

*The 208BHS is standard equipped with a 60" x 80" queen bed, or an optional Murphy Bed with Jack Knife sofa, shown here.*



2 *Optional Outfitter Package (See page 4 for details)*



# EXTREME FLEXIBILITY

The Nano Extreme Toy Hauler is designed to take your interests to the extreme, from the ultimate tailgate party, to the soccer field or an off-road adventure. 220EXT has a convenient flip-up table with two bar stools, a galley with a pantry, a roll-over sofa with plenty of overhead storage for extra gear, and a private 60" x 80" queen bedroom and full bathroom suite.

Toy Hauler	220 EXT
Hitch Weight	720
Carrying Capacity	2,208
UVW	4,292
GVWR	6,500
Exterior Length (Bumper to Hitch)	26'
Exterior Height (Includes A/C)	10' 2"
Interior Height (Coach)	78"
Awning Length	15'
Fresh Water Capacity (gal.)	50
Grey Water Capacity (gal.)	35
Waste Water Capacity (gal.)	35

Refer to chart descriptions on page 10



## TOY HAULER

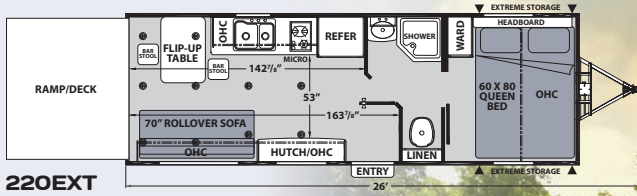

220EXT

Grab your good friends and head out for the time of your life! The Apex Nano Extreme Toy Hauler takes you and your gear where the action is in style.

220EXT shown.



## GET OUT THERE WHERE THE ACTION IS



Apex Nanos deliver many of the amenities of a larger travel trailer in a smaller, easy to tow package. From tailgating to kayaking, to 4-wheeling, they're the perfect lightweight solution for active people on the go.

Nano 208BHS kitchen shown





# ACTION PACKAGES

## OFF GRID PACKAGE

This package is available on Nano and 7-1/2' wide Ultra Lite models.



### Showermiser (N/A 215RBK)

#### Water Saver System

- Saves Fresh Water
- Saves Grey Water Tank Capacity
- Fill Fresh Water from Inside the RV

Visit [aquaviewinc.com](http://aquaviewinc.com) for more information



#### 12 Volt Outlets

- Pass-thru and Outside Kitchen



#### High Volume Power Roof Vent

- Dometic Fan-Tastic Vent
- 3-Speeds
- Quiet Operation
- 9.3 CFM Air Circulation



#### Dual LP Tanks with Cover

- (2) 20 lb. Tanks with Cover for Longer Camping Time

#### Jaboni 100 Watt Solar Panel with 10 AMP Control Charger to Battery

- High Efficiency Solar Cells
- 10 AMP Solar Charge Controller



## NANO STANDARD FEATURES

### Nano Package (Mandatory)

- Vacuum-bonded Azdel/Fiberglass Walls
- Vacuum-bonded Laminated Crowned Roof/Ceiling
- Fiberglass Front Cap w/LED Lighting and Front Window
- Aluma-cage Construction
- Laminated Aluminum Framed Floor
- Schwintek Slide System (N/A 15X, 20X, 185BH, 187RB, 220 EXT)
- Enclosed Underbelly w/Forced Air Heat (Double axle models)
- Outside Speakers
- Stabilizer Jacks (4)
- Digital TV Antenna w/Cable Hook-ups and WiFi Capability
- DSI Gas/Electric Water Heater
- Stainless Steel Microwave
- Flush-mount 2-Burner Cooktop
- Flush-mount Sink Covers
- AM/FM Stereo w/Bluetooth
- Skylight in Bath
- Evergreen Sleep Mattress
- Two-Tone Grey Fiberglass Exterior Sidewalls
- Dark Grey Exterior Rear Wall (N/A 15X, 20X)
- LED Interior Lighting Throughout
- LP Port
- Double Door Refrigerator (N/A 15X)
- Solar Prep
- Hot/Cold Outside Shower
- Swing Away Assist Handle
- Black Tank Flush
- Access Doors Under Dinette
- Magnetic Door Catches

### Interior and Décor

- Pewter Maple Cabinetry
- Seamless Countertops
- Overhead Bedroom Cabinets w/Side Wardrobes
- Congoleum DiamondFlor Flooring
- Grey Night Shades Throughout
- Pedestal Dinette Table
- Large Oversized Booth
- Hardwood Mortise and Tenon Cabinet Door Frames
- Residential Comforter (Select models)
- Stile and Rail Cabinet Front Construction
- LP Leak Alarm
- Fire Extinguisher
- Smoke Alarm
- Carbon Monoxide Detector
- Radius Entrance Door w/Window
- Radius Thumb Latch Baggage Doors
- Corrosion Resistant Powder Coated Frame
- Dual Battery Tray
- Break Away Switch
- Stone Guard
- Pass-thru Storage
- Double Entry Step
- Dexter® E-Z Lube® Axles
- Nitro Filled Radial Tires
- Heated and Enclosed Underbelly w/Forced Air (Double axle models)
- Schwintek Slide Room System

### Electrical/Heating/AC

- Detachable Marine Style Power Cord
- Outside Receptacle GFI
- USB Chargers
- Direct Vent Furnace
- 13.5K BTU A/C
- 55 Amp Power Center

### Galley

- Double Bowl Sink w/Covers
- Flush-mount 2-Burner Cooktop
- 6 Cu. Ft. Double Door Refrigerator/Freezer
- Stainless Steel Microwave
- Seamless Edge Countertops
- Matte Black Hardware

### Bath and Water

- Power Bath Vent
- Water Heater Bypass Valve
- Demand Water Pump
- Hand-crafted Wood Medicine Cabinet
- Below Floor Low Point Drains
- Foot Flush Toilet
- Separate Sink and Shower/Tub Plumbing
- 6 Gal. Gas/Electric DSI Hot Water Heater

### Exterior/Construction

- Aluma-Cage Construction
- Vacuum-bonded, Aluminum Trussed Roof w/Dicor Crossflex Roof Membrane (R-11 - 7 1/2' wide)
- Vacuum-bonded Azdel Fiberglass Sidewalls (R-9)
- Laminated Aluminum Framed Floor (R-11)
- 20# LP Tank
- Dicor Crossflex Synthetic Thermoplastic Roofing System
- Gutter Rail
- Deadbolt Lock
- Tinted Safety Glass Radius Windows

## OUTFITTER PACKAGE

This package is available on Nano models only, and includes contemporary exterior graphics, plus:



All Terrain Tires with Aluminum Rims



Toy Lock



Front Bike Rack



## NANO OPTIONAL FEATURES

### Comfort Package (Mandatory)

- 20,000 Direct Vent Furnace
- Power Awning w/LED Lighting
- 13.5k BTU A/C
- Spare Tire and Carrier

### Additional Options

- Murphy Bed (203RBK, 208BHS Only)
- 12V Tank Heater Pads
- Off Grid Package
- Outfitter Package



## NANO EXPANDABLES

These expandable travel trailers offer the advantages of a hard wall camper with the fresh air sleeping of a pop-up tent camper.

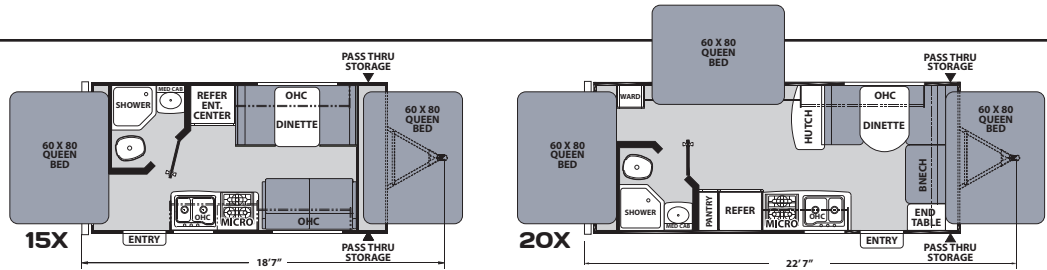

**NANO TRAVEL TRAILERS** deliver many of the amenities of a larger travel trailer in a smaller, easy to tow package.

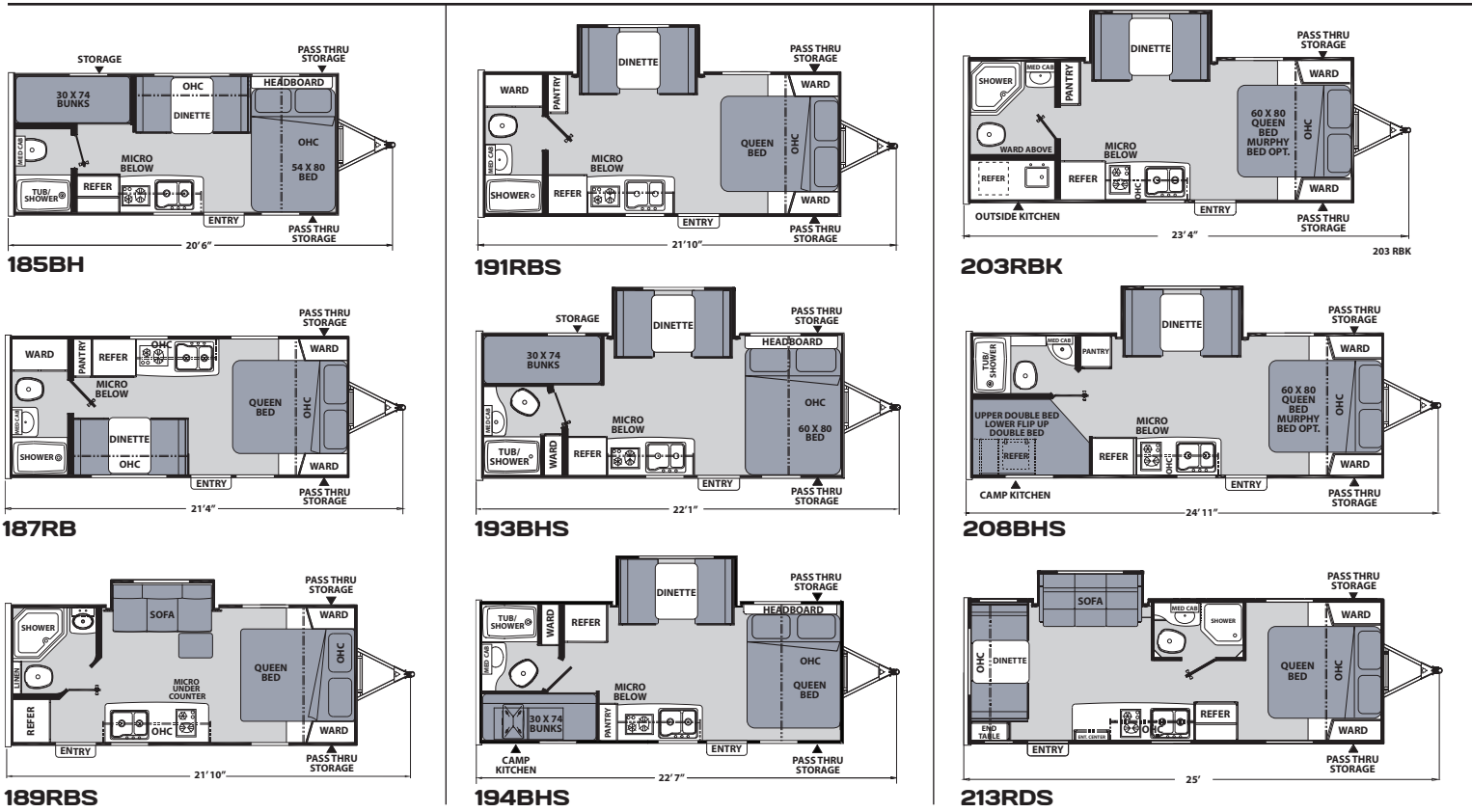

NANO MODEL	EXPANDABLES					TRAVEL TRAILERS					
	15X	20X	185BH	187RB	189RBS	191RBS	193BHS	194BHS	203RBK	208BHS	213RDS
Hitch Weight	360	464	350	316	418	406	370	338	478	516	467
Carrying Capacity	860	1,244	930	746	1,227	1,234	1,185	904	2,084	2,052	2,174
UWW	2,940	3,456	2,870	3,054	3,473	3,466	3,515	3,796	3,916	3,948	3,826
GVWR	3,800	4,700	3,800	3,800	4,700	4,700	4,700	4,700	6,000	6,000	6,000
Exterior Length (Bumper to Hitch)	18' 7"	22' 7"	20' 6"	21' 4"	21' 10"	21' 10"	22' 1"	22' 7"	23' 4"	24' 11"	25'
Exterior Height (Includes A/C)	9' 9"	10'	9' 10"	9' 9"	9' 11"	9' 10"	9' 10"	9' 10"	9' 9"	10'	9' 11"
Interior Height (Coach)	77"	77"	77"	77"	77"	77"	77"	77"	77"	77"	77"
Awning Length	12'	14'	12'	12'	12'	12'	12'	14'	15'	14'	15'
Fresh Water Capacity (gal.)	30	30	50	50	50	50	50	50	50	50	50
Grey Water Capacity (gal.)	30	30	30	30	30	30	30	30	35	35	35
Waste Water Capacity (gal.)	30	30	30	30	30	30	30	30	35	35	35

Refer to chart descriptions on page 10





### TERA TRAVEL TRAILERS

Adventure awaits in this small trailer with big amenities. These mighty little campers boast the same solid construction as other Apex models, and include a full bath with shower and toilet, a 6 cu. ft. refrigerator and a 60" x 80" queen bed. (15T Only)

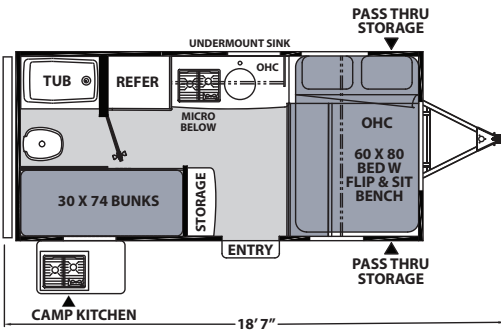

15T

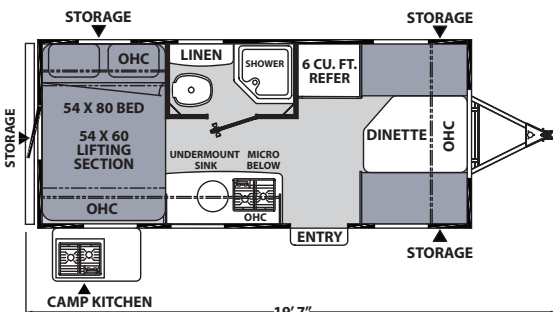

16T



The 15T has the amenities of home with a fully functioning kitchen, residential sleeping with room to relax, a full bath and ample storage.

### TERA OPTIONAL PACKAGES

#### Explore Package

- 15" All Terrain Tires
- Aluminum Rims
- Front Bike Rack
- Toy Lock

#### Boondock Package

- Dual LP Tanks w/Cover
- 100W Solar Panel Mounted on Roof
- 10 AMP Control Charger to Battery

Tera	15T	16T
Hitch Weight	396	330
Carrying Capacity	938	940
UVW	2,862	2,860
GVWR	3,800	3,800
Exterior Length (Bumper to Hitch)	18' 7"	19' 7"
Exterior Height (Includes A/C)	9' 10"	9' 10"
Interior Height (Coach)	77"	77"
Awning Length	10'	10'
Fresh Water Capacity (gal.)	50	50
Grey Water Capacity (gal.)	35	35
Waste Water Capacity (gal.)	35	35

Refer to chart descriptions on page 10



Tera comes with the optional Boondock Package and Explore Package (shown)



# APEX CONSTRUCTION

These Ultra Lite Travel Trailers are designed for towing by today's half-ton trucks, minivans and SUVs. From 18' to 34' - All units are available under 6,500 lbs.

## Construction Features

- 3M Breathable graphics
- Tinted, safety glass windows
- Welded aluminum structure, vacuum-bonded sidewalls with laminated floor
- Aluminum reinforced vacuum-bonded roof
- Dicor Crossflex roofing membrane
- Azdel composite sidewall panels
- Aerodynamic front profile with fiberglass front cap and integrated window
- Dual 20 lb. LP tanks (Nanos have a single 20 lb. LP tank)
- Insulated slam latch doors (N/A Nanos) with magnetic hold-ups
- Smooth exterior fiberglass skin
- Aluminum framed openings
- Fully enclosed, heated underbelly (Double axle models)
- Fully welded tubular aluminum floor structure
- Schwintek™ and rack and pinion slide systems (Deep slides)
- Congoleum® DiamondFlor flooring
- Powder E-coated, welded I-beam frame with full-depth crossmembers
- Dexter® E-Z Lube® axle hubs
- Nitrogen filled radial tires

## Dicor Crossflex Synthetic Thermoplastic Roofing System

- Extreme tear and puncture resistance
- Flexible
- Lightweight
- High solar reflectance
- High thermal emissivity



Lower Center of Gravity for Better Towability

## LIGHTWEIGHT DURABILITY

### Fiberglass Front Cap

- ¾ Front fiberglass cap for superior strength
- Automotive glass front window with superior UV protection
- Diamond plate lower stone guard
- Integrated LED accent lights

### Vacuum Bonded Sidewalls and Roof

- Stronger construction
- Lighter weight

### Apex Is Certified Green TRA Gold Level Rated

As a Certified Green RV, APEX utilizes effective production techniques in combination with healthy materials, plus efficient usage of energy and water to produce a high quality RV with less environmental impact.

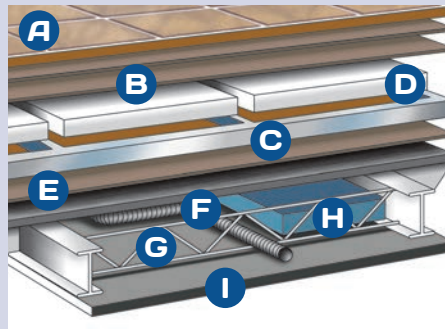

### Six Layer Laminated Floor

- A Residential durable insulated floor covering
- B Double layer Luan plywood top decking
- C Welded aluminum frame
- D Block foam structural insulation
- E Luan plywood bottom decking
- F Darco waterproof floor wrap
- G Cross member support
- H Holding tanks
- I Heated and enclosed underbelly (Double axle models)



Apex features the combination of environmentally friendly Azdel Onboard RV composite panels and Alumicage Construction to maximize towability.

Azdel composite panels are produced using a patented blend of polypropylene and fiberglass to create a durable, lightweight, water and temperature resistant, odorless and environmentally friendly wall that will increase the life of your RV.

**Weight Matters**  
50% Lighter than wood

**Let it Rain**  
No mold, rot, mildew, warping or delamination

**Unaffected by changes in temperature & humidity**

**Twice the thermal insulation of plywood**

**Free of formaldehyde, toxic odors and chemicals**

**Longer RV life**

**Quieter RVs**

**No deforestation**

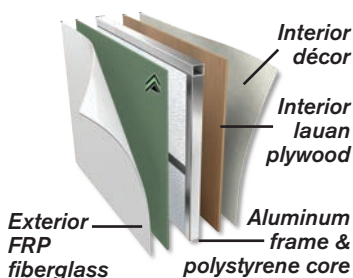

### Knock on Wood

Traditional Luan Sidewall Panels:

- Absorb and retain water
- Affected by humidity and temperature changes
- Susceptible to mold, rot, warpage and delamination
- Imported
- Heavier
- Inferior thermal insulation and noise blocking



### Avoid Costly Water Damage

- Water and wood don't mix
- Water can cause rot, mold and delamination of wood sidewall panels causing thousands of dollars in damage.



### Soak Test

- 60 Day soak test
- Wood has visible mold and decay requiring wall repair
- AZDEL was 100% unaffected





# APEX By Coachmen ULTRA LITE

*This spacious U-dinette is great for game night and cozy breakfast dining.*

*Rest easy in this queen bed with a view to the starlit night sky.*





## Entertainment Center

Comes complete with an AM/FM/CD/DVD stereo with Bluetooth, LED TV and upgraded stereo speakers. (Available on 265RBSS, 284BHSS, 287BHSS, and 293RLDS)

## APEX STANDARD FEATURES



### Wardrobe/Pantry Storage

Most Apex Ultra Lites have extra wardrobe and pantry storage. (287BHSS shown)



Ultra Lite insulated slam-latch door shown.



### Magnetic Door Closures

Holds door up and out of the way while accessing storage



### Outside Kitchen

Includes a Coleman® grill, large refrigerator, plumbed sink, gooseneck faucet and additional storage. (Standard on 203RBK, 215RBK, 251RBK, 284BHSS and 300BHS models.)



### Exterior Steps

LED lights enhance safety



### Dual LP Tanks with Cover

(2) 20 lb. Tanks with Cover for Longer Camping Time



### Camp Kitchen

Keep cold drinks and hot snacks close by! (Available on 208BHS, 245BHS, 265RBSS, 287BHSS, 289TBSS, 290BHS and 293RLDS.)



### One-Piece Seamless Countertop

This stain resistant, lighter weight countertop with no T-mold edge (Helps prevent water damage)



### Stonecast Sink

This double bowl sink is stain resistant and heat resistant up to 500° (N/A Nano models)



### Kitchen Backsplash

Easy to clean kitchen backsplash (N/A Nano)



### LED Interior Lighting

Energy efficient, bright and long lasting



### 12V Tank Heater Pads

Available on all Apex models



### Welded Aluminum Framing

Durable, lightweight aluminum cage – individually framed cut-outs to make for stronger sidewalls and reduce water leaks.

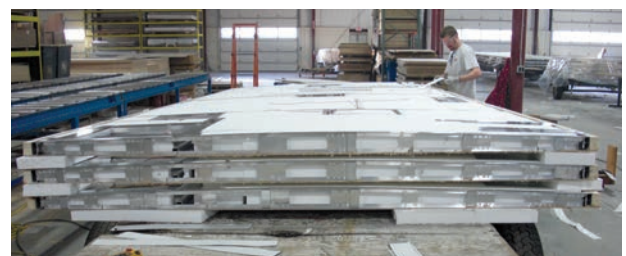

### Aluminum Reinforced Laminated Roof

Walk-on roof has evenly distributed insulation for enhanced structural integrity.



## ULTRA LITE STANDARD FEATURES

### Value Package (Mandatory)

- Vacuum-bonded Azdel/Fiberglass Walls
  - Vacuum-bonded Laminated Crowned Roof
  - Fiberglass Front Cap w/LED Lighting and Front Window
  - Laminated Aluminum Framed Floor
  - Alumina-cage Construction
  - Spare Tire
  - Outside Speakers
  - Stabilizer Jacks (4)
  - Digital TV Antenna w/Cable Hook-ups and WiFi capability
  - Enclosed Underbelly w/Forced Air Heat (Double axle models)
  - 13.5 BTU A/C
  - Stainless Steel Microwave
  - Stainless Steel Double Door Refrigerator
  - Lighted, Stainless Steel, Flush-mount, 3-Burner High Output Range w/Oven
  - AM/FM/CD/DVD Stereo w/Bluetooth
  - Skylight in Bath
  - Ball Bearing Drawer Guides
  - Evergreen Sleep Mattress
  - Two-Tone Grey Fiberglass Exterior Sidewalls
  - Dark Grey Exterior Rear Wall
  - LED Interior Lighting Throughout
  - Power Awning w/Lighting
  - LP Port
  - Exterior Cable Connection
  - Interior Convenience Center
  - Solar Prep
  - LED Motion Sensor Light in Exterior Storage Area
  - Back-up Camera Mount
  - Hard Valances
  - Night Shades
  - Hide-A-Bed Sofa (Deep Slides Only)
  - LED TV
  - Access Doors Under Dinette
  - Ground Effects (Metal skirting and ABS fender skirts)
  - Magnetic Door Catches
  - Diamond Plate Stone Guard
  - Hot/Cold Outside Shower
  - Bottle Covers
  - Black Tank Flush Kit
  - USB Charging Station
  - Swing Away Assist Handle
  - Power Tongue Jack
  - High Rise Flex Pull Kitchen Faucet
  - LED Accent Lighting
  - Backsplash Along Kitchen Countertop
  - Stonecast Sink
  - Aluminum Wheels
  - Flush Mount Sink Covers
  - Slam Latch Baggage Doors at Pass-thru
  - LED Step Light
- ### Interior and Décor
- Pewter Maple Cabinetry
  - Overhead Bedroom Cabinets w/Shirt Closets
  - Seamless Edge Countertops
  - Congoleum DiamondFlor Flooring
  - Grey Night Shades Throughout
  - Residential Comforter

- Pedestal Dinette Table
- Large Oversized Booth or U-shaped Dinette w/Sliding Door Storage Access
- 68" Residential Sofa (Most models)
- Hardwood Mortise and Tenon Cabinet Door Frames
- Stile and Rail Cabinet Front Construction
- 32" LED TV (40" – 265RBSS, 284BHSS, 287BHSS, 290BHS, 293RLDS)
- LP Leak Alarm
- Fire Extinguisher
- Smoke Alarm
- Carbon Monoxide Detector

### Electrical/Heating/AC

- Furnace – Forced Air/Ducts Per Floorplan
- 55 Amp Power Center
- Outside Receptacle GFI
- Ducted Air Conditioner (8' Wides)
- Detachable Marine Style Power Cord
- USB Chargers

### Galley

- Power LED Lighted Range Hood
- Stonecast Double Bowl Sink w/Covers
- Matte Black Hardware
- Flush-mount 3-Burner Stovetop w/Oven
- 6 Cu. Ft. Double Door Stainless Refrigerator/Freezer

### Bath and Water

- Power Bath Vent
- 6 Gal. Gas/Elec. DSI Hot Water Heater
- Water Heater Bypass Valve
- Demand Water Pump
- Hand-crafted Wood Medicine Cabinet
- Below Floor Low Point Drains
- Foot Flush Toilet
- Tub Surround
- Glass Shower Door – 34" Neo-angle Showers

### Sleeping

- Double Over Double Bunks w/Shelves
- Bedroom Vent (28' and up)

### Exterior/Construction

- Double 20# LP Tanks
- Alumina-Cage Construction
- Vacuum-bonded, Aluminum Trussed Roof w/Dicor Crossflex Roof Membrane (R-11 – 7 1/2' wide, R-14 – 8' wide)
- Vacuum-bonded Azdel/Fiberglass Sidewalls (R-9)
- Laminated Aluminum Framed Floor (R-11)
- Gutter Rail
- Dead Bolt Lock
- Tinted Safety Glass Radius Windows
- Radius Entrance Door w/Window
- Radius Slam Latch Baggage Doors
- I-beam Chassis Construction
- Corrosion Resistant Powder Coated Frame
- Dual Battery Tray
- Heated and Enclosed Underbelly w/Forced Air (Double axle models)
- Break Away Switch
- Schwintek Slide Room System (N/A Deep slides)
- Double/Triple Entry Step
- Dexter® E-Z Lube® Axles
- Nitro Filled Radial Tires

## ADDITIONAL OPTIONS

- Frameless Windows
- 15K BTU A/C Upgrade
- 50 Amp Service w/Second (Forced) 13.5K BTU A/C
- 12V Tank Heater Pads
- Theater Seating
- Recliners (2)

## 7-1/2' WIDE ULTRA LITES

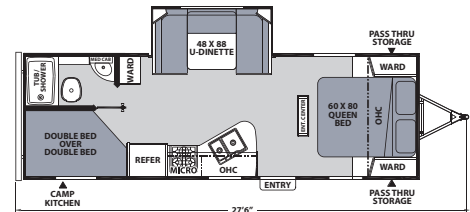
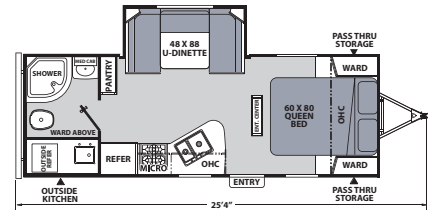

### 7-1/2' WIDE MODELS

	215RBK	245BHS
Hitch Weight	446	578
Carrying Capacity	2,135	1,914
UVW	4,365	4,586
GVWR	6,500	6,500
Exterior Length (Bumper to Hitch)	25' 4"	27' 6"
Exterior Height (Includes A/C)	9' 11"	9' 10"
Interior Height (Coach)	78"	78"
Awning Length	13'	18'
Fresh Water Capacity (gal.)	50	50
Grey Water Capacity (gal.)	35	35
Waste Water Capacity (gal.)	35	35

### 8' WIDE MODELS

	249RBS	251RBK
Hitch Weight	480	570
Carrying Capacity	2,230	2,016
UVW	4,770	4,984
GVWR	7,000	7,000
Exterior Length (Bumper to Hitch)	28' 3"	28' 11"
Exterior Height (Includes A/C)	10'	10' 1"
Interior Height (Coach)	78"	78"
Awning Length	16'	16'
Fresh Water Capacity (gal.)	50	50
Grey Water Capacity (gal.)	35	35
Waste Water Capacity (gal.)	35	35

**GVWR (Gross Vehicle Weight Rating)** – is the maximum permissible weight of the unit when fully loaded. It includes all weights, inclusive of all fluids, cargo, optional equipment and accessories. For safety and product performance do NOT exceed the GVWR.

**GAWR (Gross Axle Weight Rating)** – is the maximum permissible weight, including cargo, fluids, optional equipment and accessories that can be safely supported by a combination of all axles.

**UVW (Unloaded Vehicle Weight)\*** – is the typical weight of the unit as manufactured at the factory. It includes all weight at the unit's axle(s) and tongue or pin and LP Gas. The UVW does not include cargo, fresh potable water, additional optional equipment or dealer installed accessories.

\*Estimated Average based on standard build optional equipment.

**CCC (Cargo Carrying Capacity)\*\*** – is the amount of weight available for fresh potable water, cargo, additional optional equipment and accessories. CCC is equal to GVWR minus UVW. Available CCC should accommodate fresh potable water (8.3 lbs per gallon). Before filling the fresh water tank, empty the black and grey tanks to provide for more cargo capacity.

\*\*Estimated average based on standard build optional equipment.



# 8' WIDE ULTRA LITES

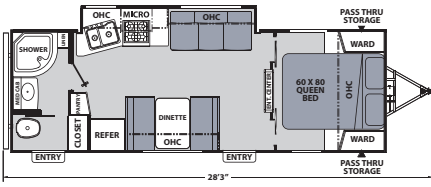

**249 RBS**

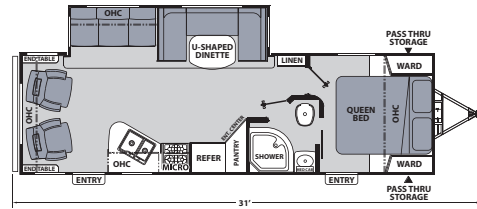

**279RLSS**

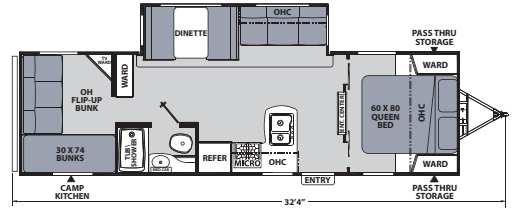

**289TBSS**

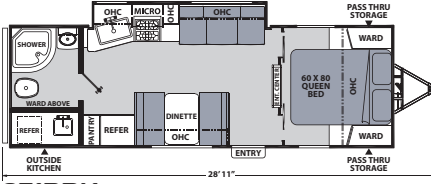

**251RBK**

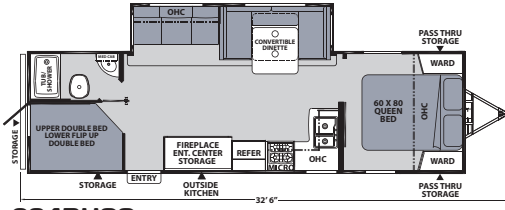

**284BHSS**

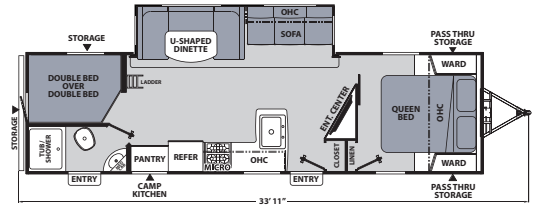

**290BHS**

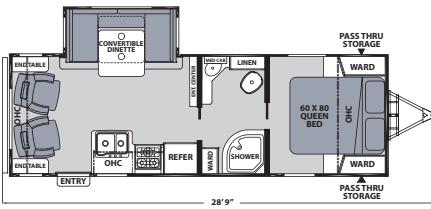

**253RLS**

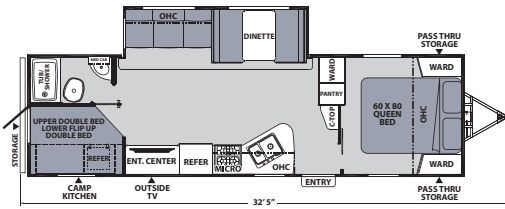

**287BHSS**

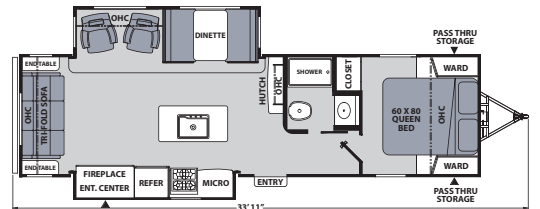

**293RLDS**

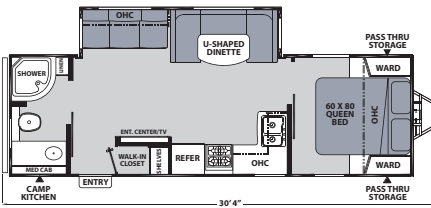

**265RBSS**

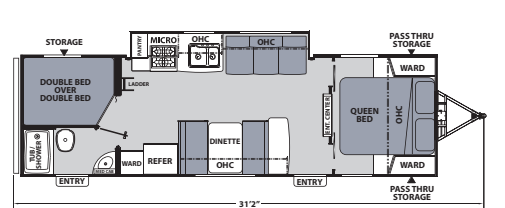

**288BHS**

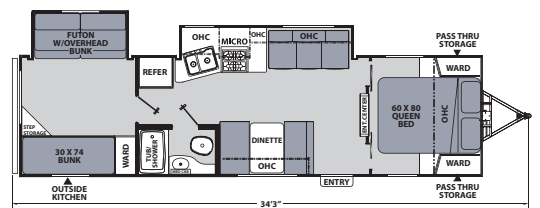

**300BHS**

253RLS	265RBSS	279RLSS	284BHSS	287BHSS	288BHS	289TBSS	290BHS	293RLDS	300BHS
562	734	620	810	792	585	715	659	832	672
2,302	1,948	2,110	1,578	1,654	2,118	1,880	1,348	1,360	1,623
5,298	5,652	5,490	6,022	5,946	4,882	5,720	6,252	6,440	5,977
7,600	7,600	7,600	7,600	7,600	7,000	7,600	7,600	7,800	7,600
28' 9"	30' 4"	31'	32' 6"	32' 5"	31' 2"	32' 4"	33' 11"	33' 11"	34' 3"
10' 5"	10' 6"	10' 6"	10' 7"	10' 6"	10' 1"	10' 6"	10' 7"	10' 7"	10' 1"
78"	78"	78"	78"	78"	78"	78"	78"	78"	78"
18'	18'	18'	18'	18'	16'	18'	20'	18'	18'
50	50	50	50	50	50	50	50	50	50
35	70	35	70	35	35	35	35	70	35
35	35	35	35	35	35	35	35	35	35

## DECOR

### SHALE

### QUARTZ





# EXPERIENCE YOUR OWN ULTRA LITE ADVENTURE

Versatile Apex Travel Trailers provide a perfect home base, wherever the road leads, as your interests grow and change.



## APEX'S FULL LINE OF ULTRA LITES ARE PERFECT FOR SMALLER TOW VEHICLES



**Coachmen**  
Recreational Vehicles  
A Division of Forest River, Inc.

# APEX

By **Coachmen**

 Find us on Facebook

423 N. Main Street • P.O. Box 30 • Middlebury, IN 46540  
To learn more about Coachmen RV and our products and see how Coachmen is making the easy life easier, visit [www.coachmenrv.com](http://www.coachmenrv.com).

### Coachmen Interactive Mobile Manuals

Download your Coachmen mobile app or visit our dynamic online manual to enhance your ownership experience. These interactive options provide incredible ease and insight into use, maintenance and enjoyment of your Coachmen product. Ranging from "How-To" videos, pictures and illustrations of various components, systems and features to fully searchable content and downloadable PDFs for individual component owner's manuals, answers are always just a click away.



### YOUR APEX DEALER

Each Forest River RV is weighed at the manufacturing facility prior to shipping. A label identifying the unloaded vehicle weight of the actual unit and the cargo carrying capacity is applied to every Forest River RV prior to leaving our facilities. The load capacity of your unit is designated by weight, not by volume, so you cannot necessarily use all available space when loading your unit. All information contained in this brochure is believed to be accurate at the time of publication. However, during the model year, it may be necessary to make revisions and Forest River, Inc., reserves the right to make all such changes without notice, including prices, colors, materials, equipment and specifications as well as the addition of new models and the discontinuance of models shown in this brochure. Therefore, please consult with your Forest River dealer and confirm the existence of any materials, design or specifications that are material to your purchase decision.  
©2020 Apex by Coachmen RV, a Division of Forest River, Inc., a Berkshire Hathaway company. All rights reserved. 3/20

**24/7 EMERGENCY  
ROADSIDE ASSISTANCE  
WITH VEHICLE PURCHASE\***

<p>TOWING JUMP-STARTS TIRE CHANGES FLUID DELIVERY LOCKOUT SERVICE</p>	<p>WINCH-OUT MOBILE MECHANIC TECHNICAL SUPPORT DEALER LOCATOR SERVICES</p>
---	--



\*VALID FOR 1 YEAR FROM DATE OF PURCHASE



**COACHMEN OWNERS ASSOCIATION**

**FREE MEMBERSHIP**

[www.coachmenowners.com](http://www.coachmenowners.com)

CUSTOMER SATISFACTION

**FOREST RIVER**  
encourages you to

**BUY LOCAL**

PREFERENTIAL SERVICE

PRODUCT INFORMATION

[www.ForestRiverBuyLocal.com](http://www.ForestRiverBuyLocal.com)



**Learn More**

Scan this barcode using a QR Reader on your smart phone to learn more about Forest River.



A Berkshire Hathaway company.